

◀ P320A ▶

Item number	Description
① 4130-525A	Pedal Beater
② 4330-555A	Connector Complete for Bearing
③ 4218-560A	Spring Assy.
4450-567	Spring Hook
④ 2402-205A	Anchor Screw Assy.
⑤ ST080020040	Wing Screw
⑥ 4230-245	Radius Rod Assy.

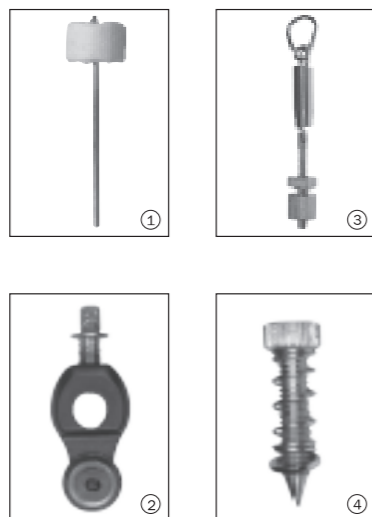

◀ C300A ▶

Item number	Description
① 3245-484A	Upper Tube
② 3623-430A	Tilter
③ 3121-355X	Cymbal Felts (2pcs/pack)
3121-355	Cymbal Felt (1pc)
④ 3621-325	Cymbal Washer
⑤ NZ080020038	Wing Nut
⑥ 3224-3010A	Wing Nut / Balt Assembly
⑦ AZ0800170A	Wing Screw
⑧ AZ0600150A	Wing Screw
⑨ 3730-095A	Memory Lock for Tube dia. 15.9mm (0.6")
⑩ 3122-045	Rubber Foot (1pc)

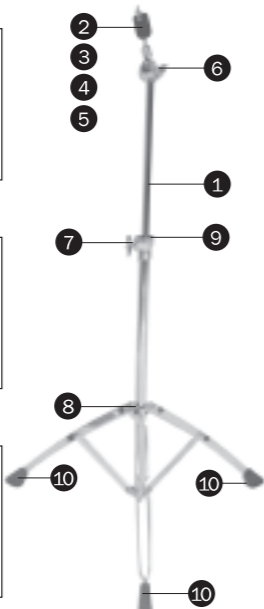

◀ B300A ▶

Item number	Description
① 3623-484A	Boom Arm
② 3623-430A	Tilter
③ 3121-355X	Felts (2pcs/pack)
3121-355	Felt (1pc)
④ 3621-325	Cymbal Washer
⑤ NZ080020038	Wing Nut
⑥ 3224-3010A	Wing Nut / Balt Assembly
⑦ AZ0800170A	Wing Screw
⑧ AZ0600150A	Wing Screw
⑨ 3730-095A	Memory Lock for Tube dia. 15.9mm (0.6")
⑩ 3122-045	Rubber Foot (1pc)

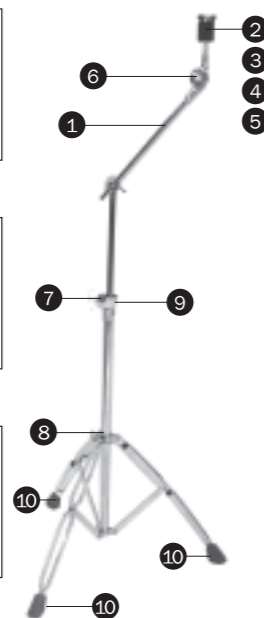

Item number	Description
① 0112-1800A-XX	18"BD Metal Hoop with inlay, for Q Series
0112-2000A-XX	20"BD Metal Hoop with inlay, for Q Series
0112-2200A-XX	22"BD Metal Hoop with inlay, for Q Series
Replace xx with color code	
② 0246-418BB-MP	18"BD Head, Batter Side
0246-420BB-MP	20"BD Head, Batter Side
0246-422BB-MP	22"BD Head, Batter Side
0246-618CB-MP	18"BD Black Head, Logo Side
0246-620CB-MP	20"BD Black Head, Logo Side
0246-622CB-MP	22"BD Black Head, Logo Side
③ LUG-0703G	Lug Assy. Chrome Plated
④ 0704-891	BD Hook, Chrome Plated
⑤ SFM0551000H	Tension Rod, Chrome Plated (1pc)
⑥ 1900M12362A	Badge (w / Gasket and screws)
⑦ 7230J0001A	BD Spur
7201-675	Adjustment Knob
7201-685A	Rubber Foot for BD Spur (1pc)
⑧ 6300B	BD Mount Complete
AZ0800170A	Wing Screw(1pc)





Item number	Description
① 0104-0804	8" TT Hoop, Chrome Plated, 4 Holes
0104-1006	10" TT Hoop, Chrome Plated, 6 Holes
0104-1206	12" TT Hoop, Chrome Plated, 6 Holes
0104-1306	13" TT Hoop, Chrome Plated, 6 Holes
0104-1406	14" TT / FT Hoop, Chrome Plated, 6 Holes
0104-1606	16" TT / FT Hoop, Chrome Plated, 6 Holes
0104-1806	18" TT / FT Hoop, Chrome Plated, 6 Holes
② 0246-308CT-MP	8" TT Head (Batter / Bottom)
0246-310CT-MP	10" TT Head (Batter / Bottom)
0246-312CT-MP	12" TT Head (Batter / Bottom)
0246-313CT-MP	13" TT Head (Batter / Bottom)
0246-314CT-MP	14" TT / FT Head (Batter / Bottom)
0246-316CT-MP	16" TT / FT Head (Batter / Bottom)
0246-318CT-MP	18" TT / FT Head (Batter / Bottom)
③ LUG-0701G	Lug Assy., Chrome Plated
④ SFM0550450H	Tension Rod, Chrome Plated (1pc)
⑤ 1900M12362A	Badge (w/ Gasket and screws)
⑥ 34601880A	FT Leg (1pc)
34602685	Rubber Foot for FT Leg (1pc)
⑦ 6200M	TT Mount
34505875A	FT Mount
NZ080024044	Wing Nut (1pc) for TT Mount
ST080020040	Wing Screw (1pc) for FT Mount



Item number	Description
① 0104-1408	14" SN Hoop, Batter Side, Chrome Plated, 8 Holes
0104-14081	14" SN Hoop, Snare Side, Chrome Plated, 8 Holes
② 0246-114CT-MP	14" SN Head, Batter Side
0246-314SS-MP	14" SN Head, Snare Side
③ LUG-0742P	Lug Assy. for Wood Shell (Type P)
LUG-0702P	Lug Assy. for Metal Shell
④ SFM0550450H	Tension Rod, Chrome Plated (1pc)
⑤ 1900M12362A	Badge (w/ Gasket and Screw)
⑥ 0612-1720A	SN Throw-off, Release Side Assy. for Wood Shell, Chrome Plated
0612-1820A	SN Throw-off, Butt Side Assy. for Wood Shell, Chrome Plated
⑦ 18323850A	14" Snare Wire Assy., Chrome Plated



◀ TH630 ▶

Item number	Description
① 6801-024	Ball Rod
② 6600-095A	Memory Lock for Tube dia. 25.4mm (1")
③ 9550-9010A	Wing Nut / Bolt Assembly

◀ S300A ▶

Item number	Description
① 1018-105	Rubber Sleeve(1pc)
② AZ0800170A	Wing Screw
③ AZ0600150A	Wing Screw
④ 3730-095A	Memory Lock for Tube dia. 15.9mm (0.6)
⑤ 3122-045	Rubber Foot (1pc)



◀ H300A ▶

Item number	Description
① 2670-346A	Clutch
② AZ0600150A	Wing Screw
③ 2004-355A	Felts (2pcs/pack)
2004-355	Felt (1pc)
2671-360	Plastic Knob
④ 2008-380	Pull Rod of Upper Tube
⑤ 2245-075X	Upper Tube
2121-320A	Cymbal Seat
⑥ 2121-330	Felt Cymbal Base
⑦ AZ0800170A	Wing Screw
⑧ 2402-205A	Anchor Screw Assy.
⑨ 3122-045	Rubber Foot (1pc)

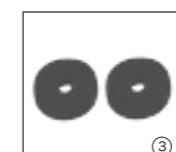
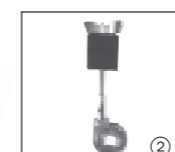
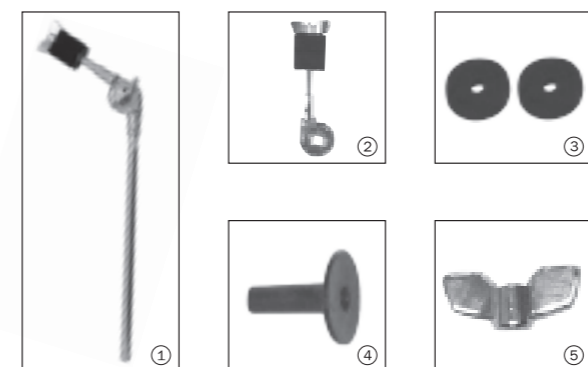
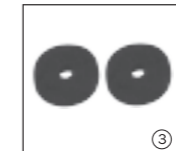
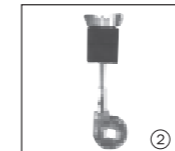
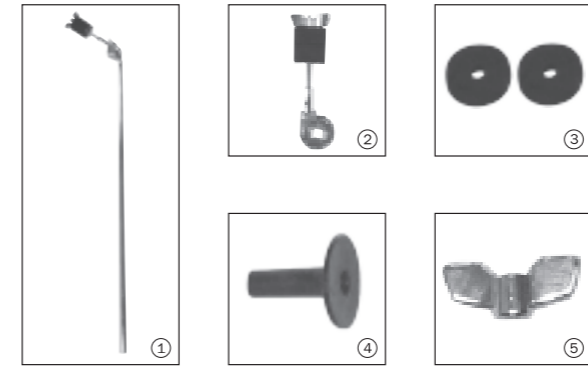
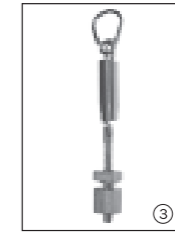
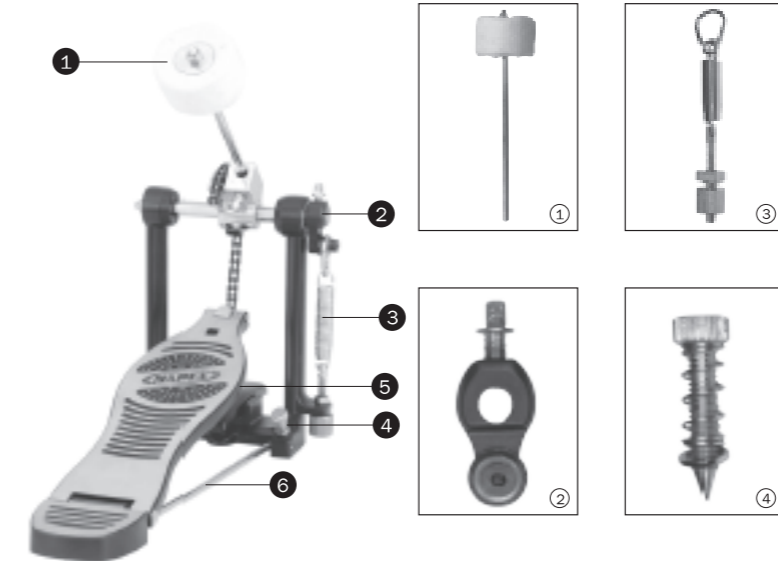
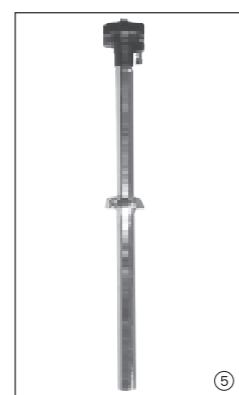
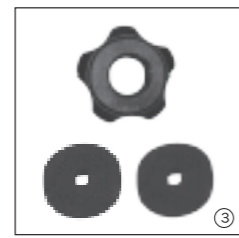
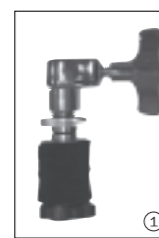
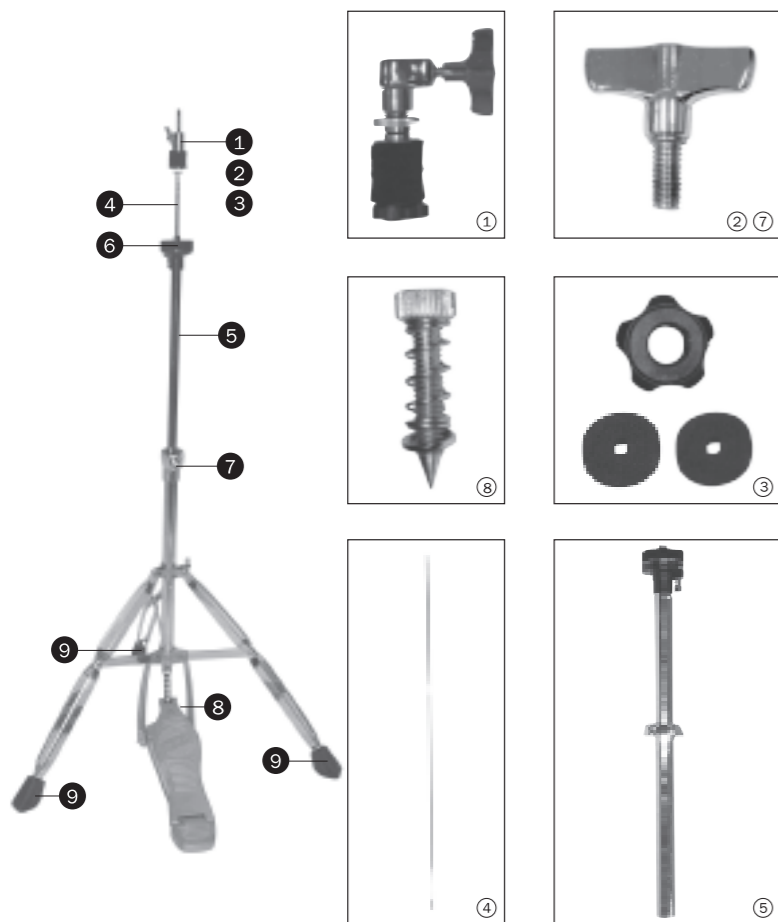
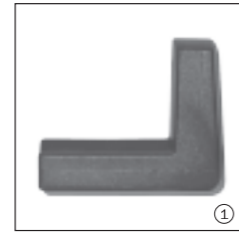
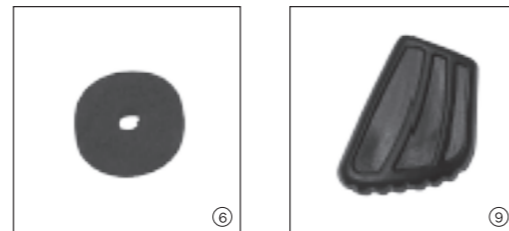

◀ P320A ▶

Item number	Description
① 4130-525A	Pedal Beater
② 4330-555A	Connector Complete for Bearing
③ 4218-560A	Spring Assy.
4450-567	Spring Hook
④ 2402-205A	Anchor Screw Assy.
⑤ ST080020040	Wing Screw
⑥ 4230-245	Radius Rod Assy.



◀ C300A ▶

Item number	Description
① 3245-484A	Upper Tube
② 3623-430A	Tilter
③ 3121-355X	Cmbal Felts (2pcs/pack)
3121-355	Cymbal Felt (1pc)
④ 3621-325	Cymbal Washer
⑤ NZ080020038	Wing Nut
⑥ 3224-3010A	Wing Nut / Balt Assembly
⑦ AZ0800170A	Wing Screw
⑧ AZ0600150A	Wing Screw
⑨ 3730-095A	Memory Lock for Tube dia. 15.9mm (0.6")
⑩ 3122-045	Rubber Foot (1pc)



◀ B300A ▶

Item number	Description
① 3623-484A	Boom Arm
② 3623-430A	Tilter
③ 3121-355X	Felts (2pcs/pack)
3121-355	Felt (1pc)
④ 3621-325	Cymbal Washer
⑤ NZ080020038	Wing Nut
⑥ 3224-3010A	Wing Nut / Balt Assembly
⑦ AZ0800170A	Wing Screw
⑧ AZ0600150A	Wing Screw
⑨ 3730-095A	Memory Lock for Tube dia. 15.9mm (0.6")
⑩ 3122-045	Rubber Foot (1pc)

